

A-SERCON S.A.

Al Servicio de la Construcción

CATALOGO N° 1

MOLDAJES

VIVIENDAS

(SOLO VENTA)

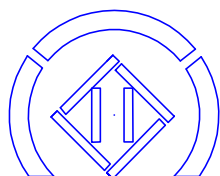

**SOLIDARIO
LECHUGA**

FONO: 780 3637 Fax: 852 6554
Celular: 881 924 95

A-SERCON S.A.

NOMENCLATURA

S	SOBRECIMIENTO
C.C.	CADENA CONVENCIONAL
C.D.	CADENA DESPLAZADA
C.L.	CADENA LOSA
C.I.	CADENA INTERIOR
P.E.	PILAR ESQUINA
P.T.	PILAR TAPA
P.D.T.	PILAR DOBLE TAPA
D.D.	DETALLE DIMENSIONES
A.	APLICACIONES

 SOLIDARIO LECHUGA	NOMENCLATURA	

A-SERCON S.A. - EYZAGUIRRE 3805 . PUENTE ALTO
TELEFONO: 780 3637---CELULAR 881 92495

A-SERCON S.A.

SOBRECIMIENTO

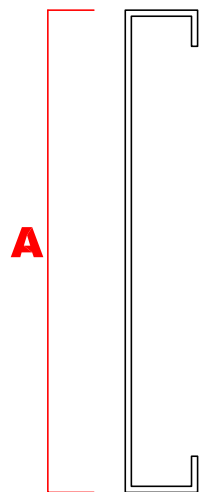

CADENA

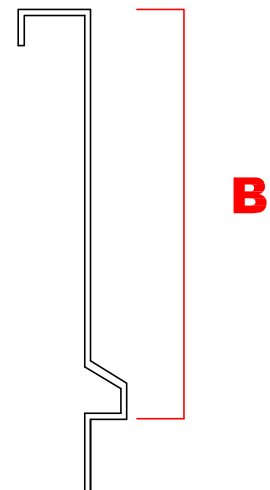

Medidas según planos

	PANELES	ESCALA 1:25
	SOBRECIMIENTO Y CADENA	PLANO P.C.S. 01

A-SERCON S.A. - EYZAGUIRRE 3805 . PUENTE ALTO
TELEFONO: 780 3637---CELULAR 881 92495

A-SERCON S.A.

CADENA/LOSA
INTERIOR

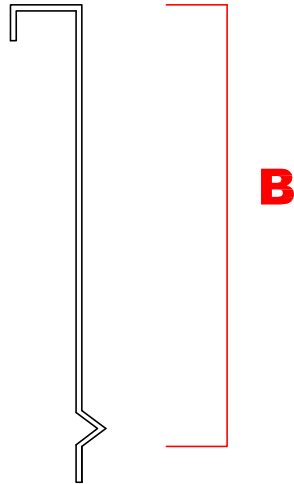

CADENA
DESPLAZADA

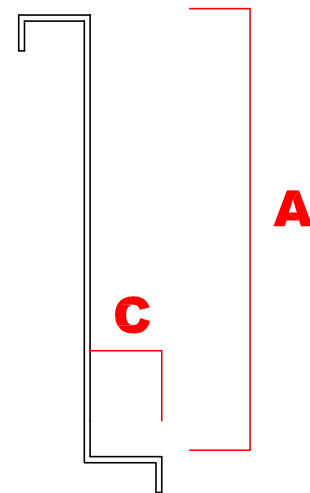

Medidas según planos

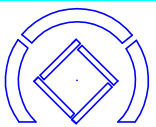
 SOLIDARIO LECHUGA	PANELES		ESCALA 1:25
	CADENA/LOSA INTERIOR	CADENA DESPLAZADA	PLANO P.C.I.D 02

A-SERCON S.A.

PILAR ESQUINA

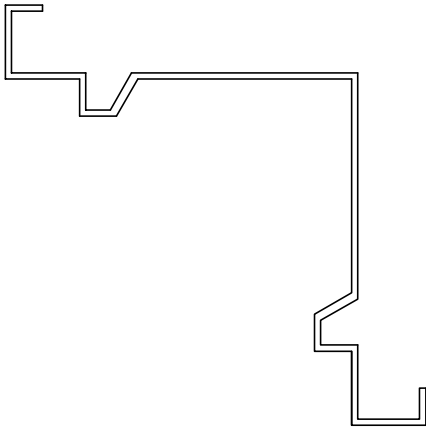

PILAR TAPA



 SOLIDARIO LECHUGA	PANELES	ESCALA 1:25
	PILARES	PLANO P.T.E 03

A-SERCON S.A.

Arco, estacas y tirantes sobrecimiento

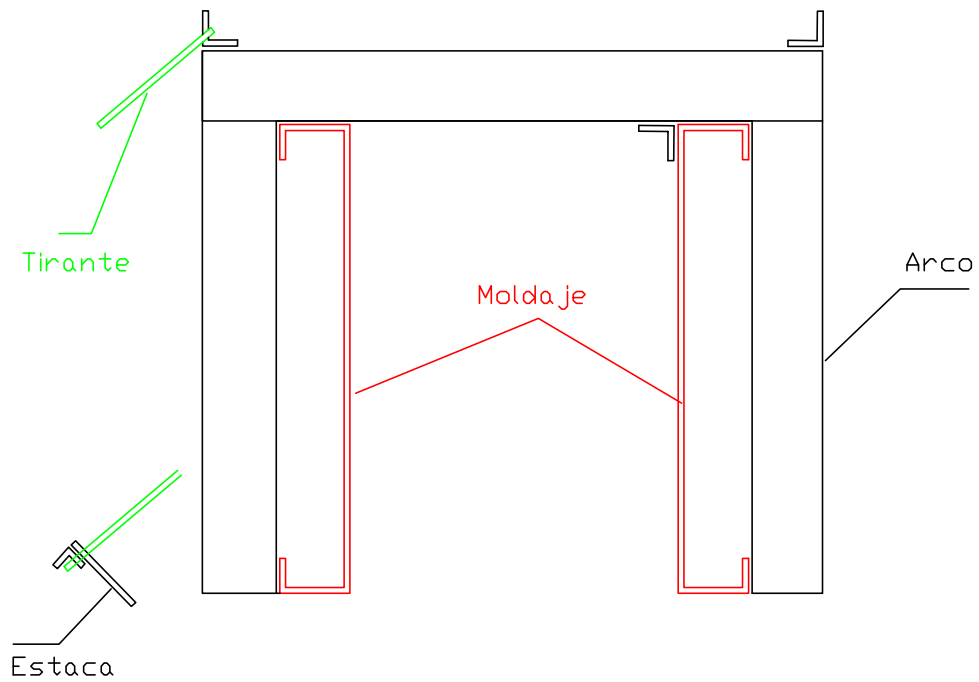

 <p>SOLIDARIO LECHUGA</p>	SOBRECIMIENTO	ESCALA 1:25
	SOBRECIMIENTO, SUJECION POR ARCOS	PLANO S.04

A-SERCON S.A.

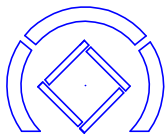
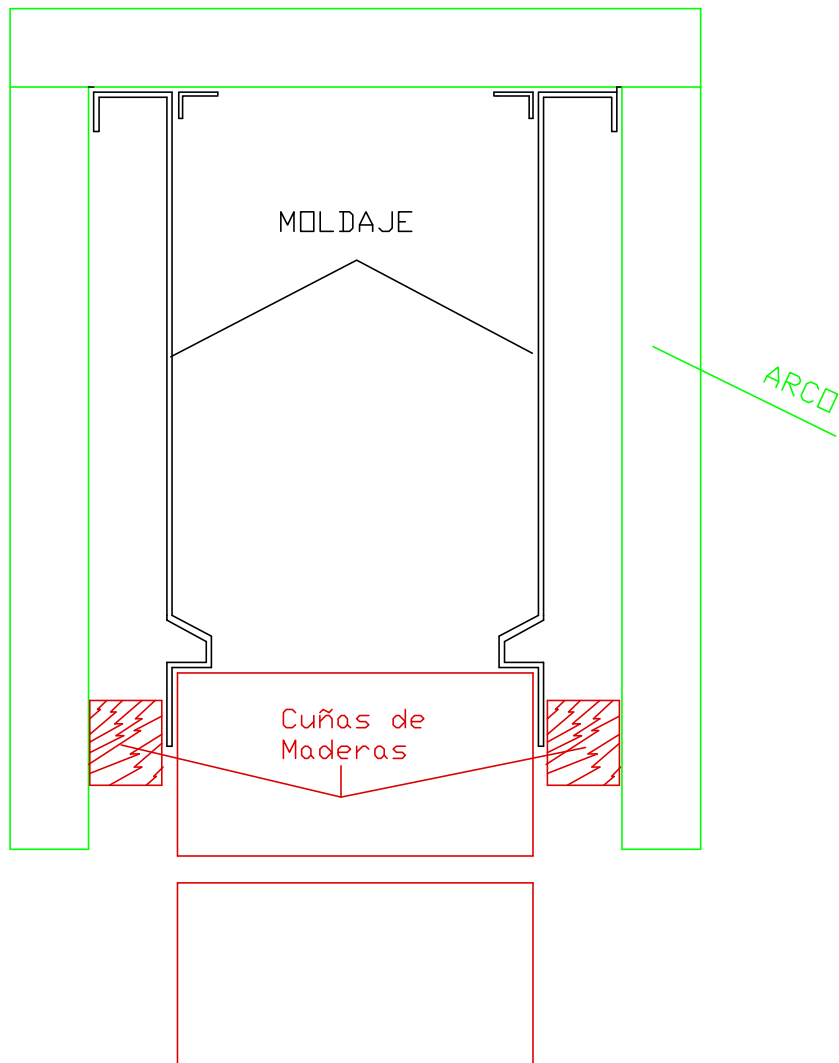

**SOLIDARIO
LECHUGA**

CADENA

**CADENA RECTA SUJECION
POR ARCOS**

ESCALA 1:25

PLANO C.R.01

A-SERCON S.A.

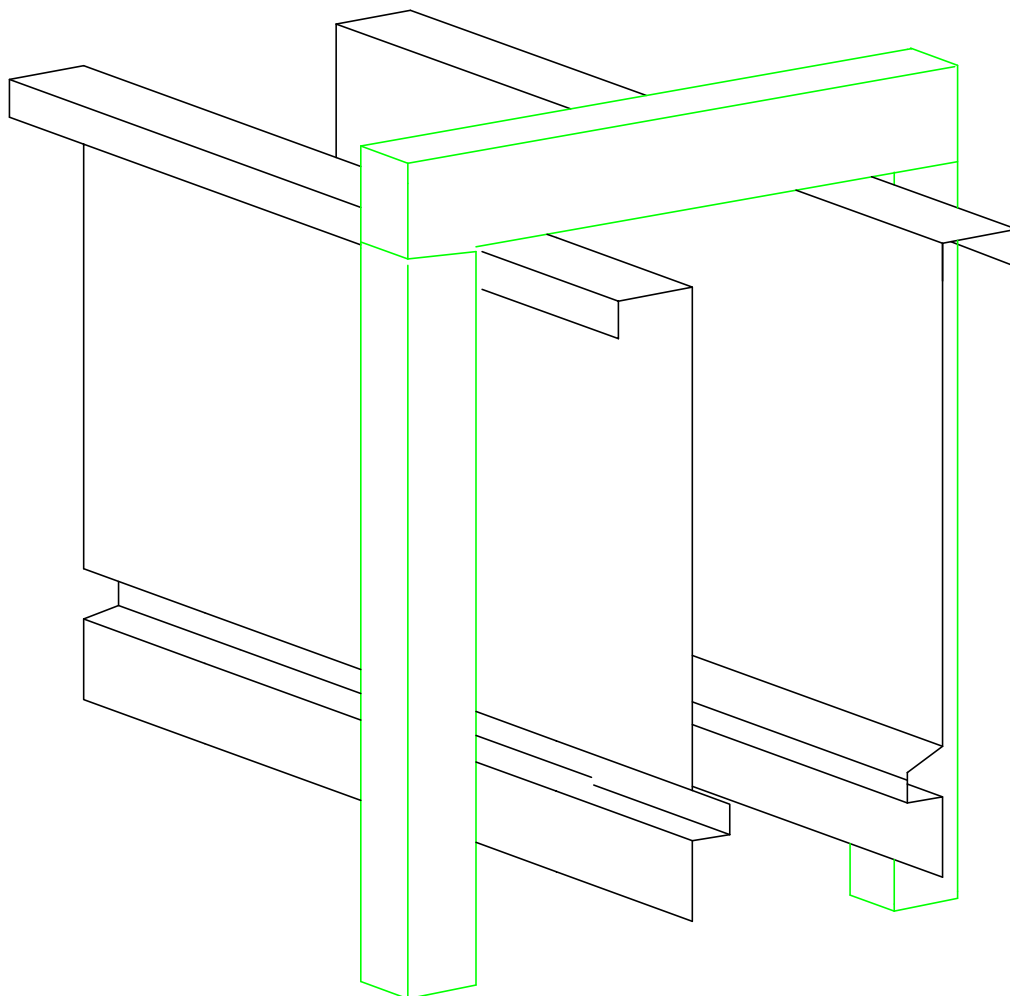

 SOLIDARIO LECHUGA	CADENA	ESCALA 1:25
		PLANO C.R.02

A-SERCON S.A. - EYZAGUIRRE 3805 . PUENTE ALTO
TELEFONO: 780 3637---CELULAR 881 92495

A-SERCON S.A.

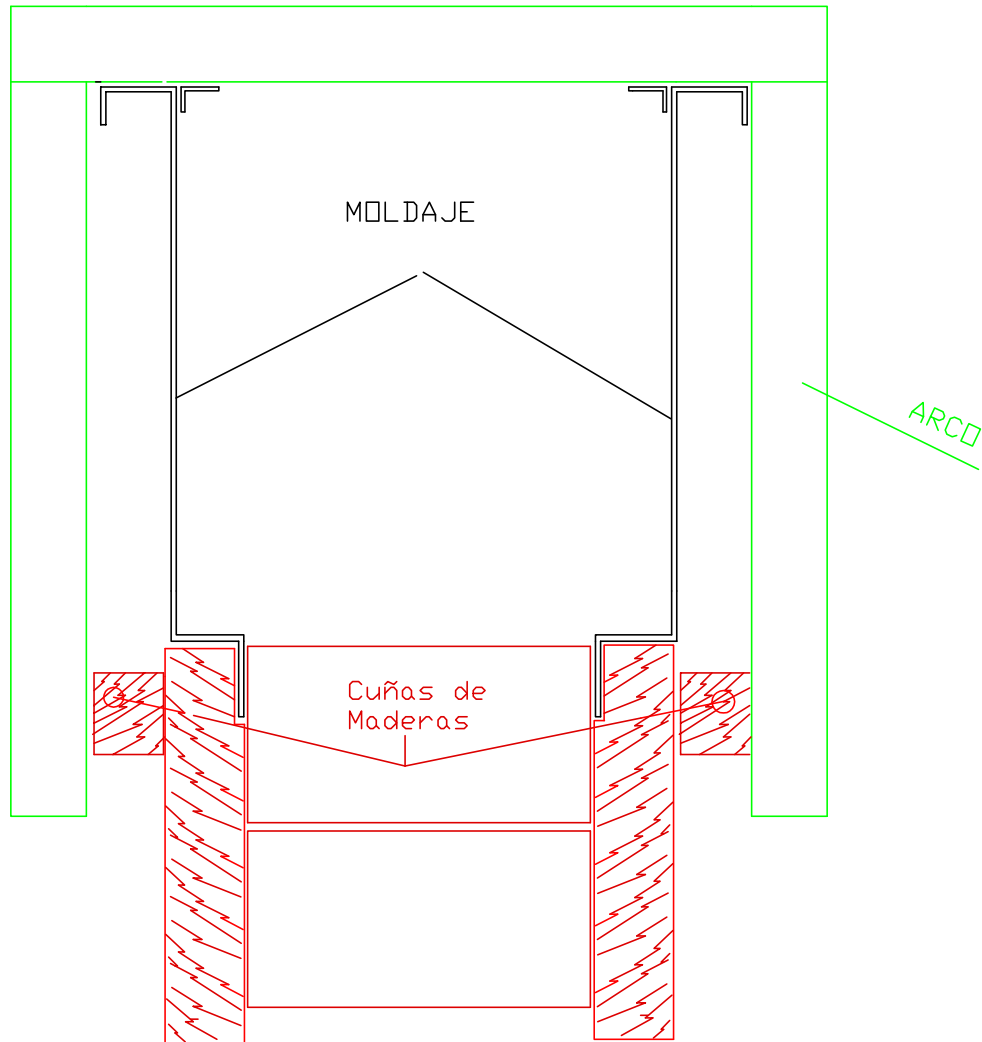

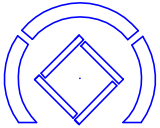
 SOLIDARIO LECHUGA	CADENA	ESCALA 1:25
	CADENA DESPLAZADA	PLANO C.D.01

A-SERCON S.A. - EYZAGUIRRE 3805 . PUENTE ALTO
TELEFONO: 780 3637---CELULAR 881 92495

A-SERCON S.A.

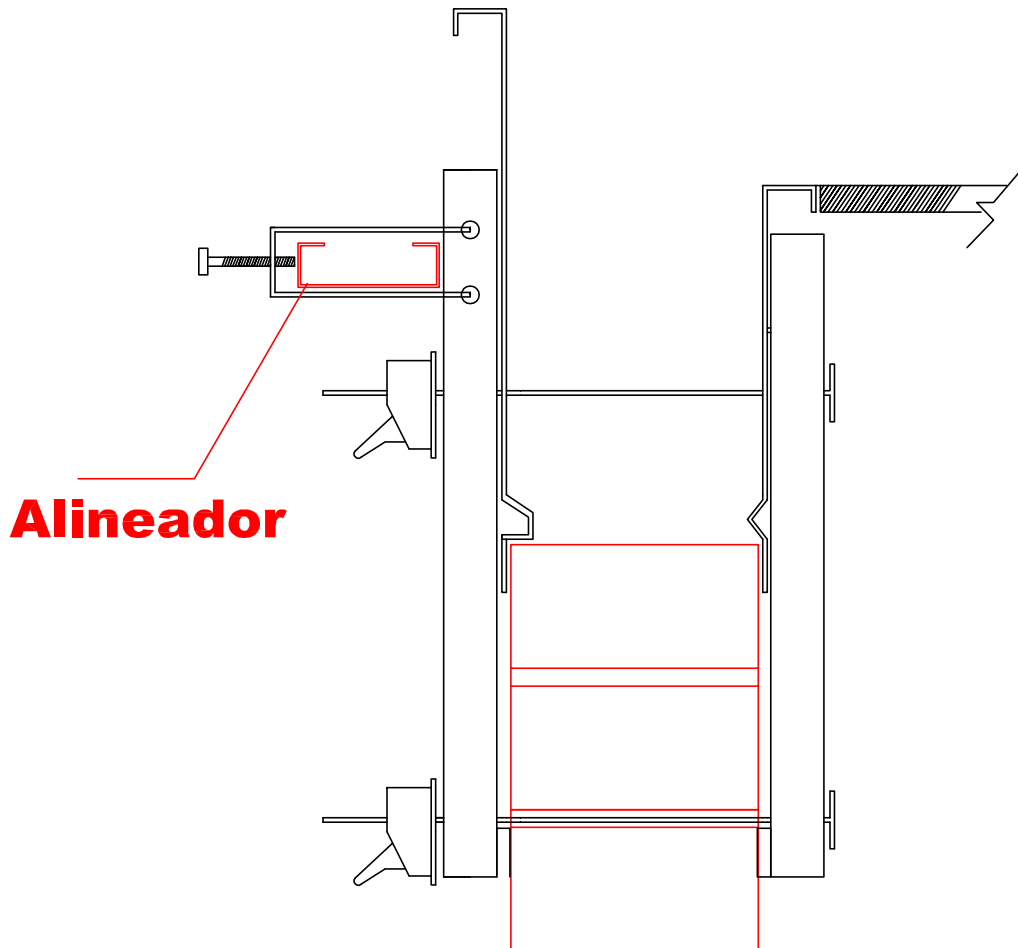

 <p>SOLIDARIO LECHUGA</p>	CADENA	ESCALA 1:25
	CADENA/LOSA CON ALINEADOR PASADORES Y FIJADORES	PLANO C.L.01

A-SERCON S.A. - EYZAGUIRRE 3805 . PUENTE ALTO
TELEFONO: 780 3637---CELULAR 881 924 95

A-SERCON S.A.

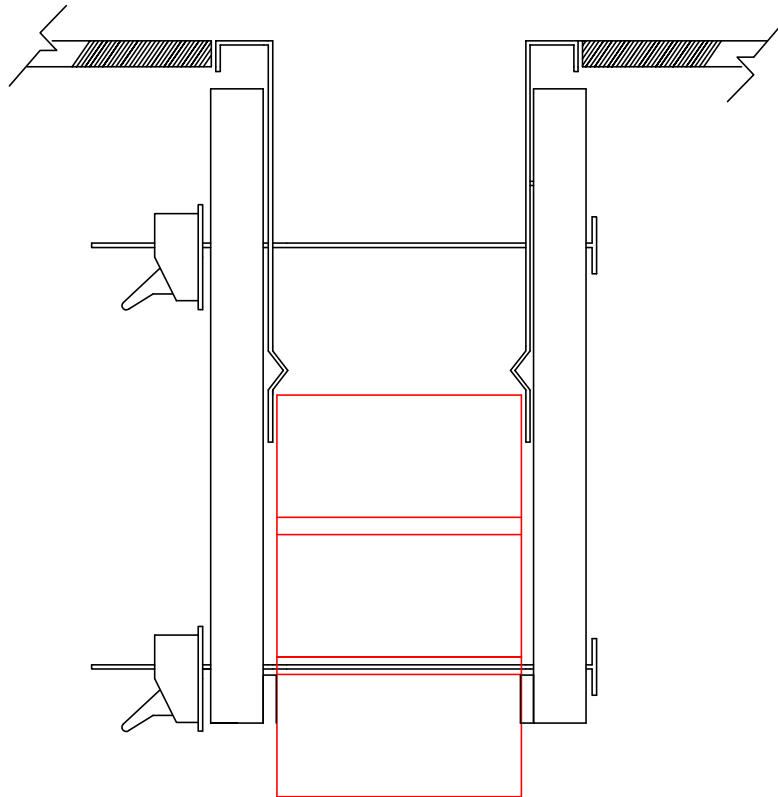

 SOLIDARIO LECHUGA	CADENA	ESCALA 1:25
	CADENA/LOSA INTERIOR	PLANO C.L.I.01

A-SERCON S.A. - EYZAGUIRRE 3805 , PUENTE ALTO
TELEFONO: 780 3637---CELULAR 881 924 95

A-SERCON S.A.

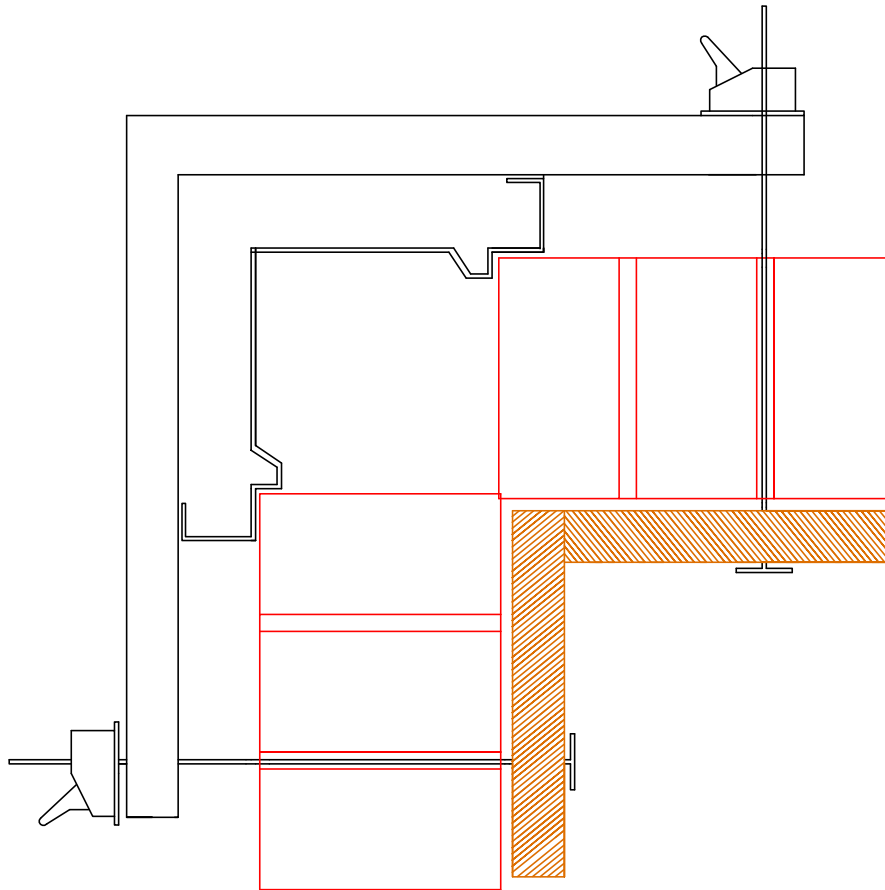

 SOLIDARIO LECHUGA	PILARES	ESCALA 1:25
	PILAR ESQUINA	PLANO P.E.01

A-SERCON S.A. - EYZAGUIRRE 3805 , PUENTE ALTO
TELEFONO: 780 3637---CELULAR 881 92495

A-SERCON S.A.

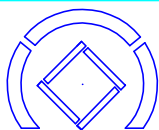
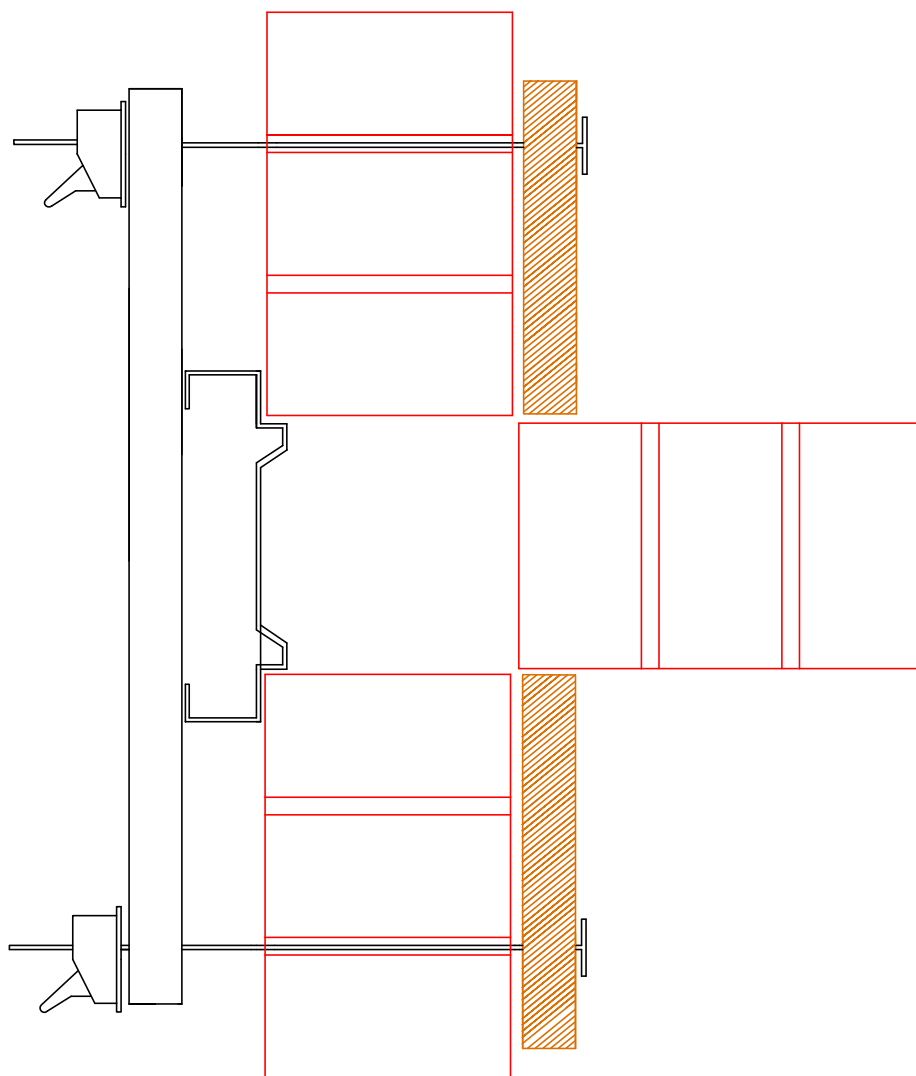

**SOLIDARIO
LECHUGA**

PILARES

**PILAR TAPA SIMPLE
TRAVESAÑO, PASADOR Y FIJADOR**

ESCALA 1:25

PLANO P.T.S.01

A-SERCON S.A. - EYZAGUIRRE 3805 , PUENTE ALTO
TELEFONO: 780 3637---CELULAR 881 92495

A-SERCON S.A.

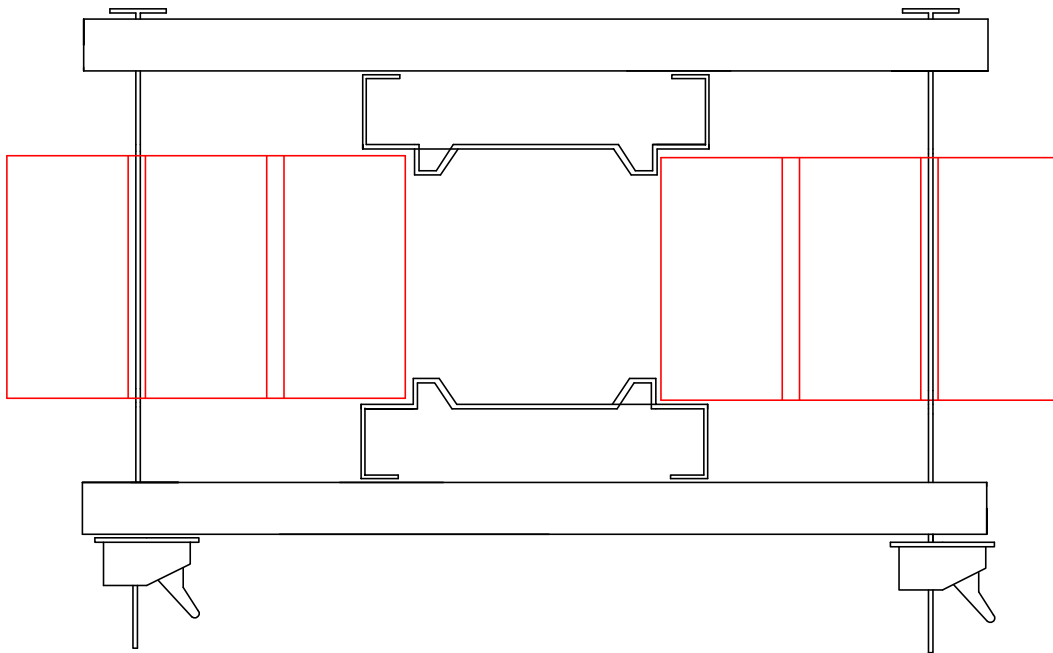

 SOLIDARIO LEHUGA	PILARES	ESCALA 1:25
	PILAR TAPA DOBLE TRAVESAÑOS, PASADOR Y FIJADOR	PLANO P.T.D.01

A-SERCON S.A. - EYZAGUIRRE 3805 . PUENTE ALTO
TELEFONO: 780 3637---CELULAR 881 92495

A-SERCON S.A.

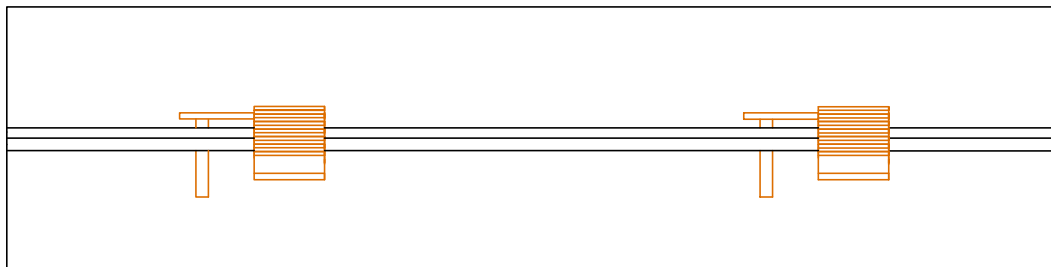
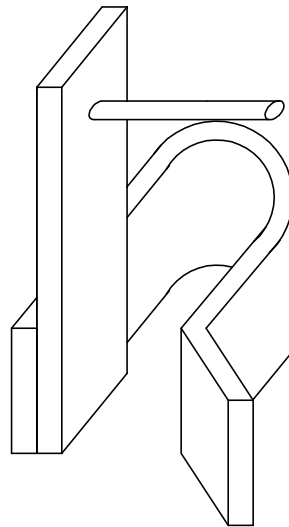

 SOLIDARIO LECHUGA	PERROS	ESCALA 1:25
	PANELES UNIDOS CON PERROS	PLANO P.U.P.01